



UHF Card Reader

User Manual

Copyright © Hangzhou Hikvision Digital Technology Co., Ltd. 2019. All rights reserved.

Any part of this manual, including text, pictures, graphics, etc., belongs to Hangzhou Hikvision Digital Technology Co., Ltd. or its subsidiaries (hereinafter referred to as "the Company" or "Hikvision"). Without written permission, no unit or individual may excerpt, copy, translate, or modify all or part of this manual in any way. Unless otherwise agreed, our company does not provide any express or implied representations or warranties in this manual.

About this manual

The products described in this manual are intended for sale and use in Chinese mainland only.

This manual is used as a guide. The photos, graphics, charts and illustrations provided in the manual are for explanation and illustration purposes only and may differ from the specific product. Due to product version upgrade or other needs, the company may update this manual, if you need the latest version of the manual, please log on to the company's official website to check (www.hikvision.com).

Hikvision recommends that you use this manual under the guidance of a professional.

Trademark Notice




HIKVISION is a registered trademark of Hikvision. Other trademarks mentioned in this manual are the property of their respective owners.

Disclaimer

- To the fullest extent permitted by law, the products described in this manual (including their hardware, software, firmware, etc.) are provided "as is" and may be defective, wrong or malfunctioning, and the Company does not provide any form of express or implied warranties, including but not limited to warranties of merchantability, satisfactory quality, fitness for a particular purpose, non-infringement of third party rights, etc., and shall not compensate for any special, incidental, incidental or consequential damages arising from the use of this manual or the use of the Company's products, including but not limited to loss of business profits, Losses arising from loss of data or documents.
- If you access the product to the Internet at your own risk, including but not limited to the product may be subject to network attacks, hacker attacks, virus infection, etc., the company will not be responsible for the abnormal operation of the product, information leakage and other problems caused by this, but the company will provide you with product-related technical support in a timely manner.
- When using this product, please strictly follow the applicable laws. The Company shall not be liable if the Product is used for infringement of the rights of third parties or other improper uses.
- In the event of a conflict between the contents of this manual and applicable laws, the provisions of the law shall prevail.

Symbol Conventions

The symbols that may be found in this document are defined as follows.

Symbol	Description
 Danger	Indicates a hazardous situation which, if not avoided, will or could result in death or serious injury.
 Caution	Indicates a potentially hazardous situation which, if not avoided, could result in equipment damage, data loss, performance degradation, or unexpected results.
 Note	Provides additional information to emphasize or supplement important points of the main text.

Contents

Chapter 1 Introduction	1
1.1 Product Introduction	1
1.2 Packing List	2
Chapter 2 Installation and Wiring	4
2.1 Installation	4
2.1.1 Mounting bracket instructions	4
2.1.2 Installation Schematic and Test Data Reference	5
2.2 Wiring	6
Chapter 3 Reader Configuration	7
3.1 Login web page	7
3.2 Basic configuration	8
3.2.1 Network configuration	9
3.2.2 Working mode	10
3.2.3 Event configuration	15
3.2.4 System maintenance	16

Chapter 1 Introduction

1.1 Product Introduction

Compatible with EPC C1 Gen2/ISO 18000-6C.

Carrier cancellation function for better anti-interference capability.

Supports EPC Dense Read Mode (DRM) for long range reading with RF output power up to 33dBm.


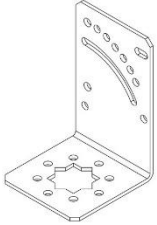
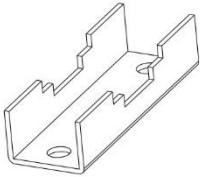
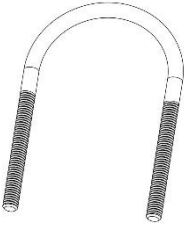

Flexible configuration and parameters for maximum tag reads and optimal performance.

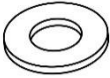

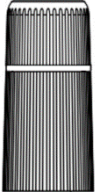


Figure 1-1 DS-TRD902-1 Reader appearance

1.2 Packing List

Table 1-1 Packing List

No.	Diagram	Name	Quantity
1		UHF Integrated Reader	1
2		L-shaped Chuck	1
3		N-shaped Chuck	2
4		U-shaped Chuck	2
5		Hex Nut	4

6		Flat Gasket	4
7		Spring Washer	4
8		RJ45 Docking Connector	1

Chapter 2 Installation and Wiring

2.1 Installation

Place the device on a flat, dry fixing table or hang it on the wall.

Keep the environment around the device as dry and well-ventilated as possible.

Ensure that there are no devices in the same UHF band near the installation site to avoid mutual interference

2.1.1 Mounting bracket instructions

The bracket is suitable for round pole with diameter 25-50MM.

Bracket adjustable angle 60 ° (such as adjusting the angle of installation only use a clamp)

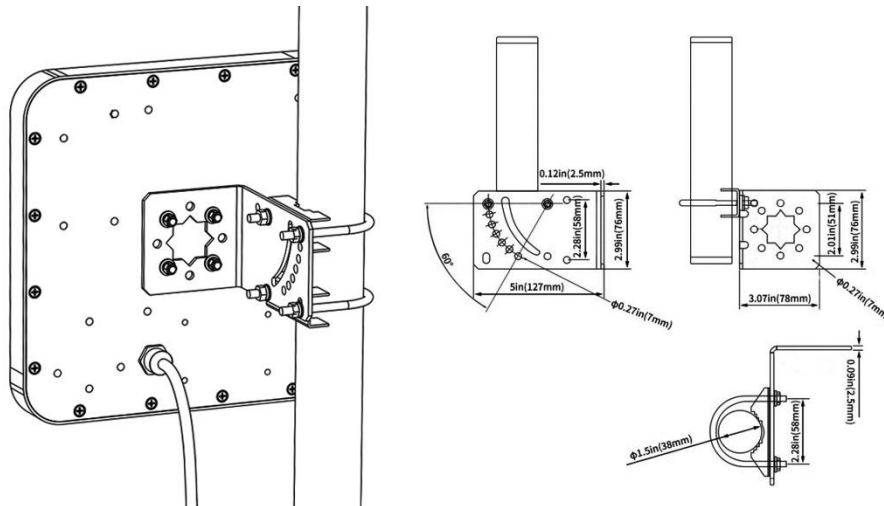


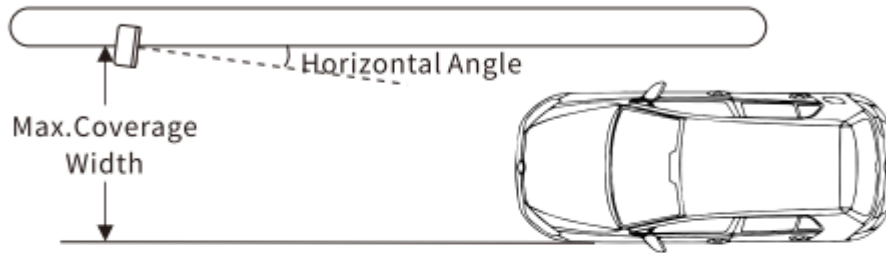
Figure 2-1 Mounting bracket

2.1.2 Installation Schematic and Test Data Reference

Entrance/Exit

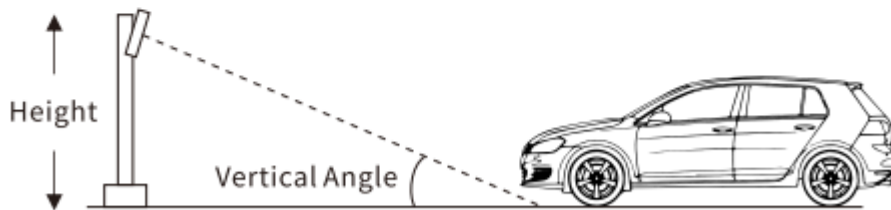
Horizontal Angle

The view angle of the UHF Read recommend 5° to the path of the movement



Vertical Angle

The angle between the UHF Read direction and the Vertical recommend 20°



Recommended

Lane Width: <3.5 m

UHF Read Installation Height: 2.5 m

Figure 2-2 Equipment Installation Schematic

Table 2-1 Data Reference

Equipment Installation Location	Setting power (dBm)	Equipment height(m)	Tag height (m)	Vertical angle of equipment	Horizontal angle of equipment	Scope of identification (Horizontal Tag) (m)	Scope of identification (Vertical Tag) (m)
Roadside	30	2.5	1	20°	5°	0-10	0-7
Roadside	25	2.5	1	20°	5°	3-5.5	0.5-4.5
Roadside	20	2.5	1	20°	5°	0	2-2.5

2.2 Wiring

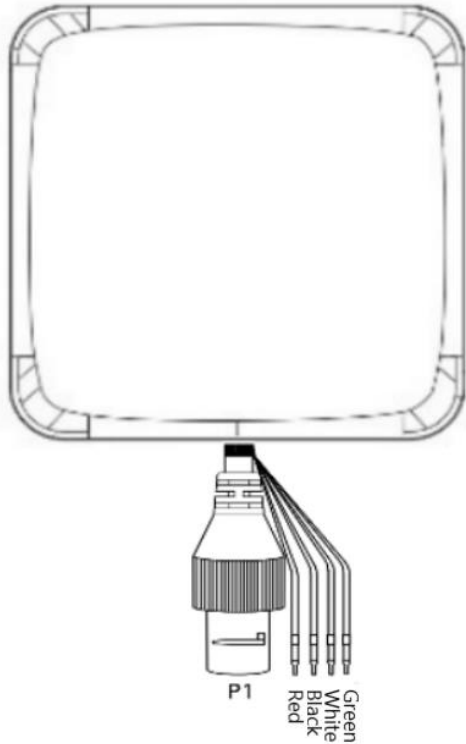


Figure 2-3 Wiring

Table 2-2 Ports Description

SN	Cable colour	Designation	function Definition
1	Red	+12V	Dc power supply positive input
2	Black	GND	Dc Power Ground
3	White	D1	Wiegand Signal Data 1
4	Green	D0	Wiegand Signal Data 2

Note

Each communication line must be used in conjunction with the signal ground return line.

Chapter 3 Reader Configuration

3.1 Login web page

1. Connect the reader to the special power adapter, plug in the network cable and antenna, and power on the device.
2. Log in to the reader's homepage, the default IP is **192.168.1.100**, enter the IP address of the reader in the address bar of the browser, and the following landing page will appear. Fill in the user name and password.
3. Enter the user name and password.
4. The default user name is root and the default password is **Hiklife@123+**, the first time you log in, you will enter the password change interface. Enter the default password in the old password box, enter the user's own configured password in the new password and the new password confirmation box, then click save and refresh the interface to re-enter the login interface, and then change the password to the user's configured password and click log in.

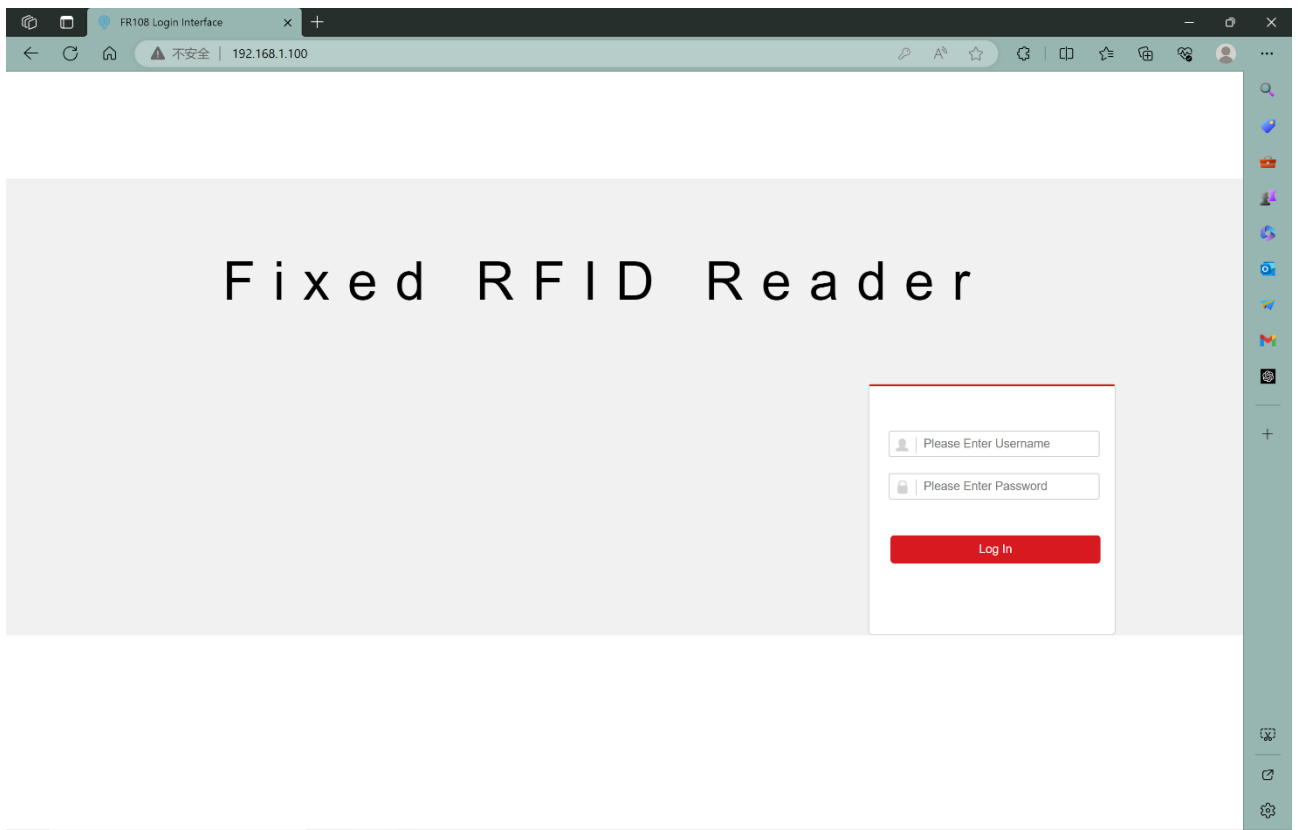


Figure 3-1 Enter the web page

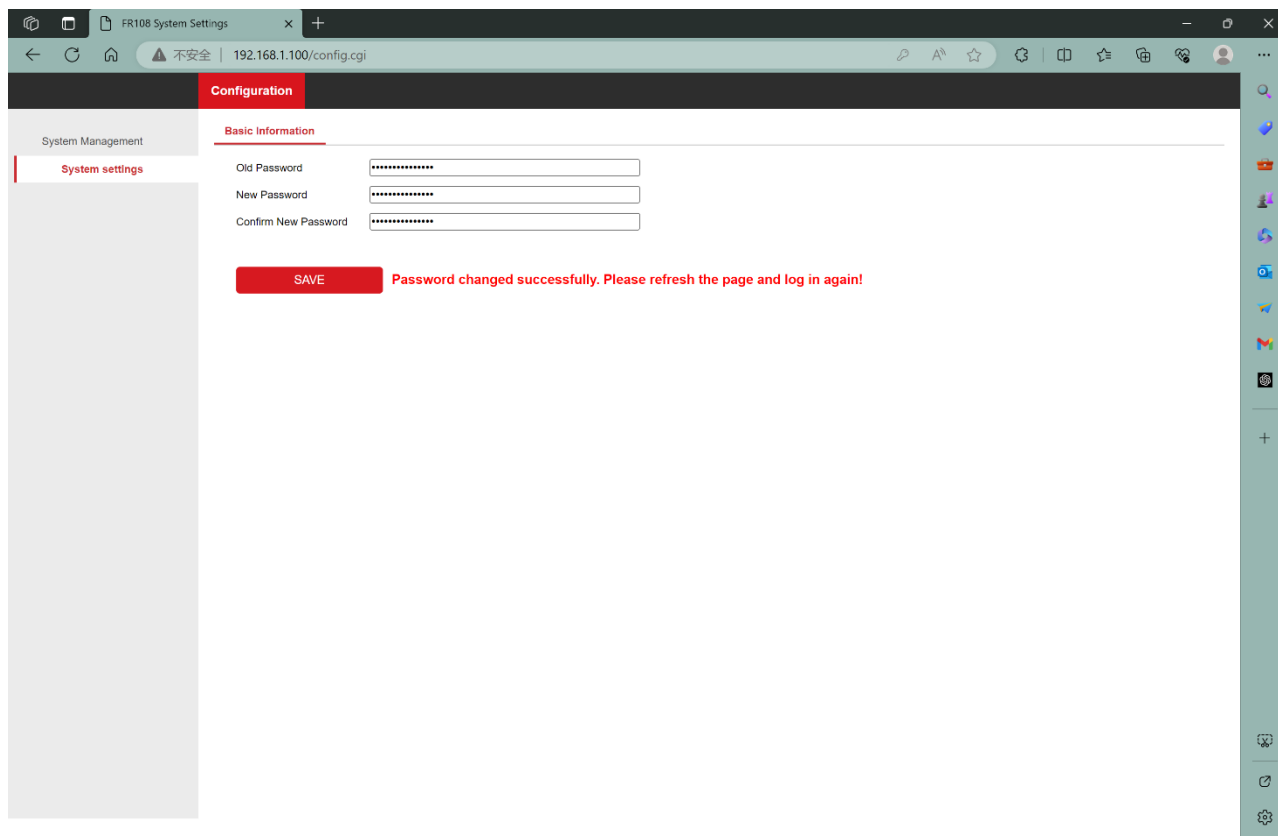


Figure 3-2 Change the password

3.2 Basic configuration

In addition to configuring the device communication mode, device serial number, IP address, listening port and other information in the Basic Settings interface. You can also display the device MAC address information, firmware version, RF module firmware version and other information, in addition to changing the configuration of the device in this interface and clicking on the Save button to reboot the device automatically.

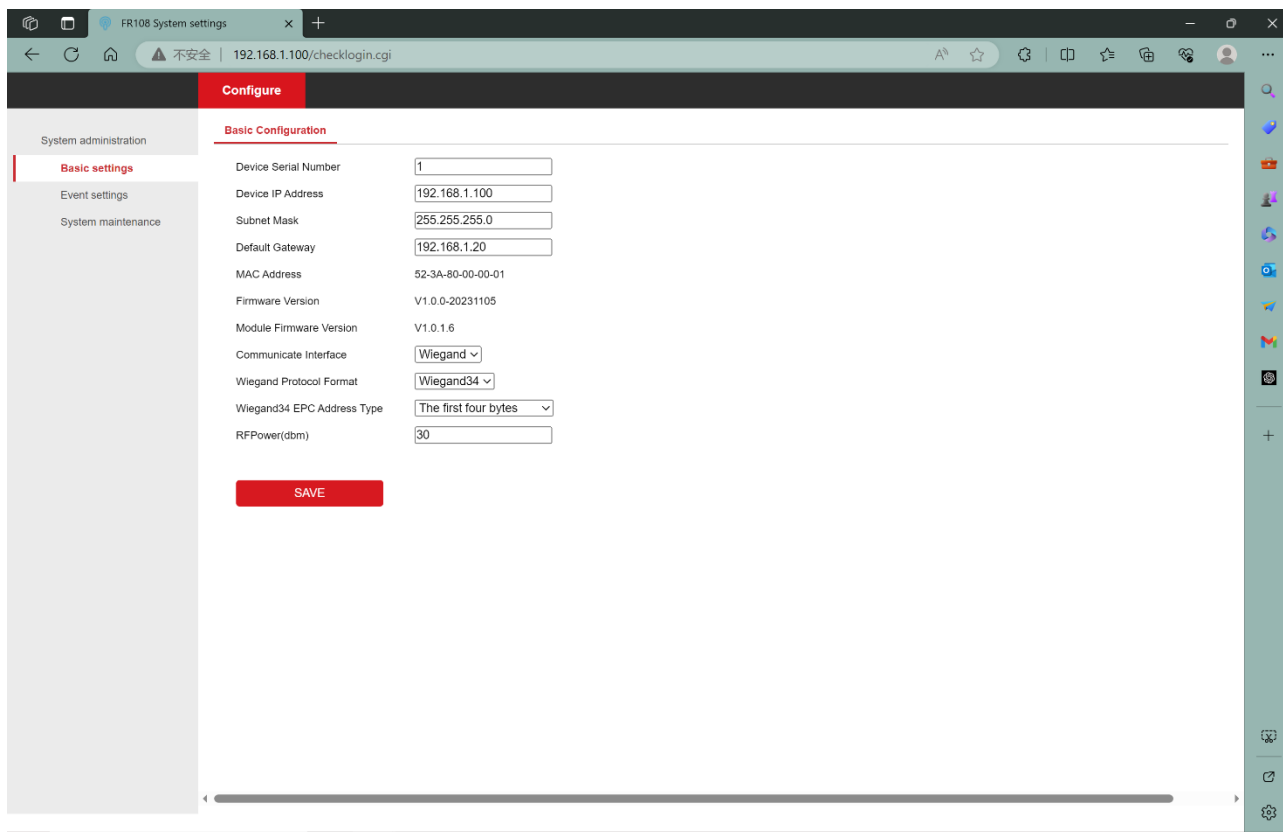


Figure 3-3 Basic configuration page

3.2.1 Network configuration

Users need to configure the IP address, subnet mask and gateway of the reader according to their current network status. For example, configure the reader's network parameters as IP, subnet mask and gateway as 192.168.1.99, 255.255.255.0, 192.168.1.20 respectively:

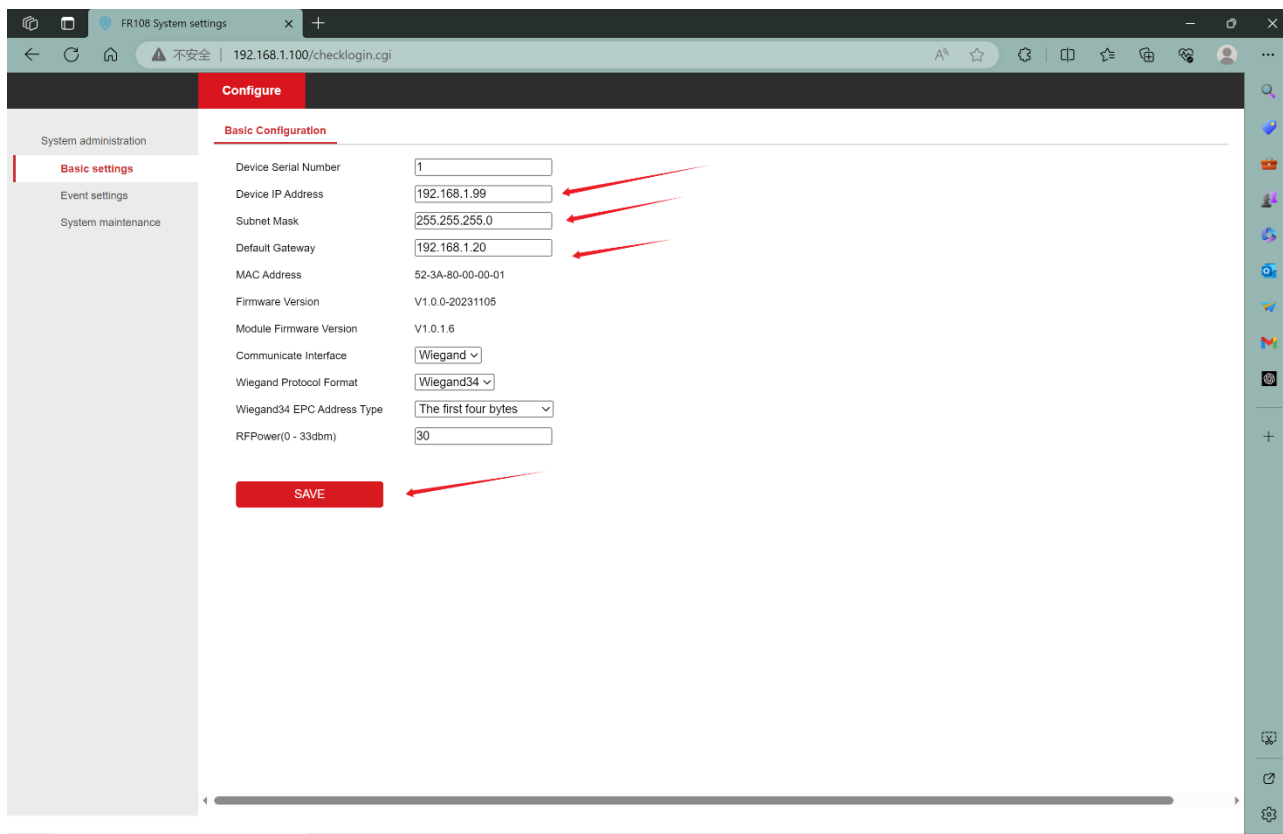


Figure 3-4 Network configuration

Note

If you have changed your IP address, you will not be able to access the web pages with the original IP address, please enter the new IP address in your browser address.

3.2.2 Working mode

The card reader has several modes of operation. In Enet mode the reader can act as a server or a client. In Wiegand mode the reader can support Wiegand 26 or Wiegand 34 protocols.

Enet mode:

In this mode, the reader can be reconfigured to either server mode or client mode. The specific configuration mode depends on customer requirements.

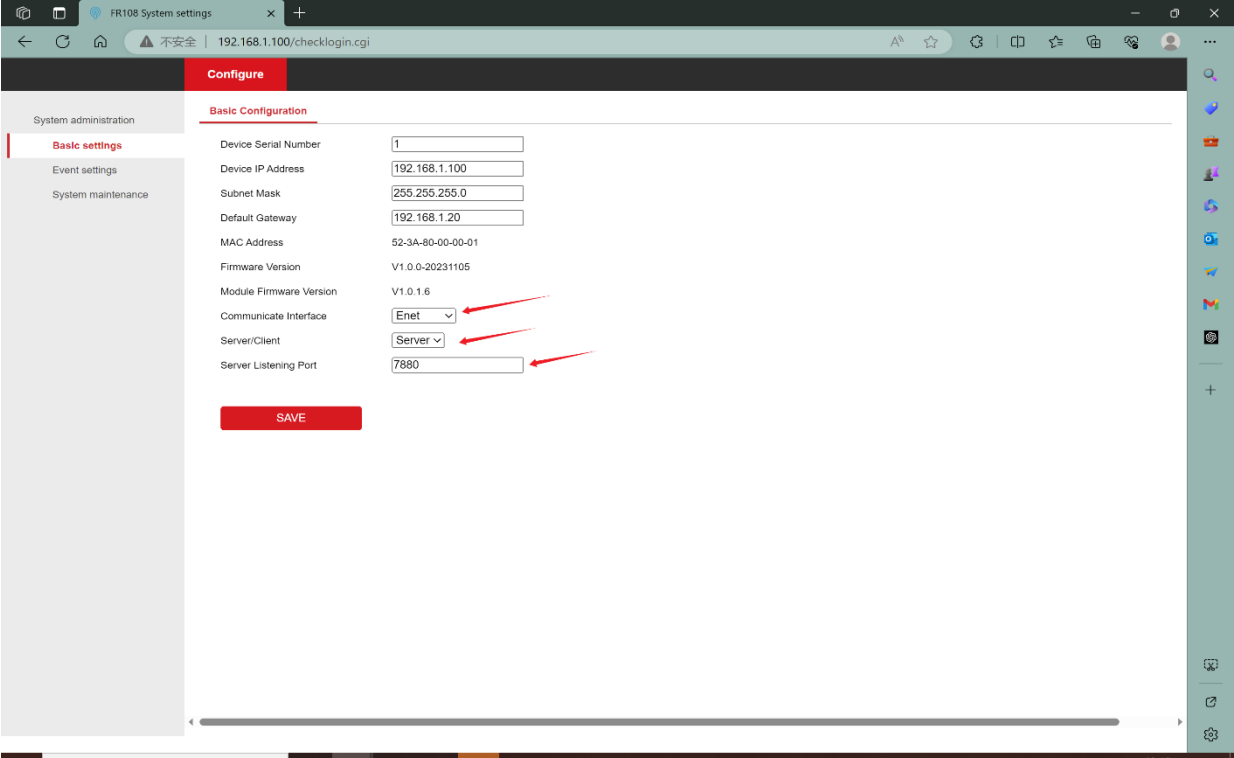


Figure 3-5 Enet server configuration

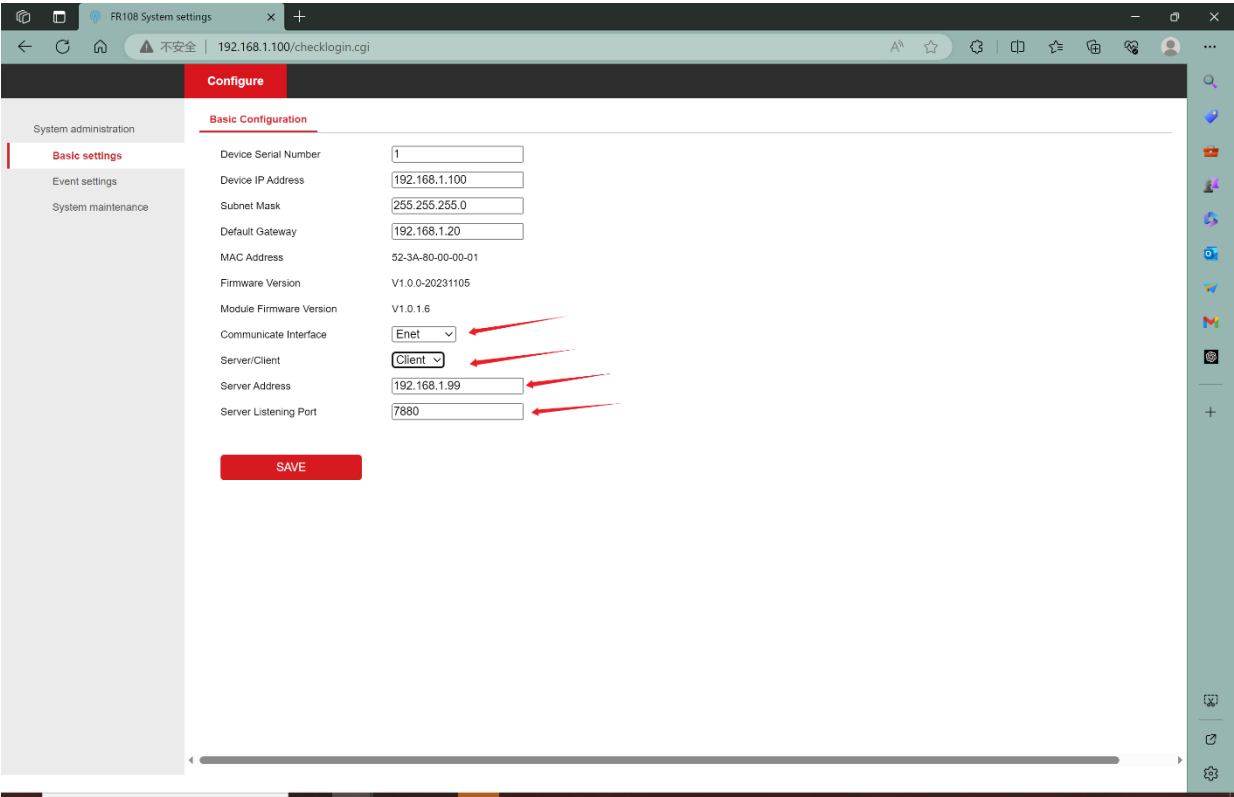


Figure 3-6 Enet client configuration

 **Note**

The reader works as the server mode. The default port is 7880. You can change it. If the reader works as the client, you need to configure the IP address and port number of the server. For example, if the IP address of the server is set to 192.168.1.99, the reader automatically connects to the server after the server restarts.

Wiegand mode:

When the working mode is Wiegand, there are two Wiegand protocols to choose from, Wiegand 26 and Wiegand 34. In addition, the user can configure the starting position of the EPC to be reported and the RF power used for the inventory tags, the configuration steps are as follows:

1. select Wiegand as the communication mode
2. select Wiegand 26 or Wiegand 34 for the Wiegand protocol format as required
3. Wiegand EPC address type according to the need to select the first three / four bytes, the last three / four bytes, as well as customized address offsets
4. Configure the RF power, click Save to wait for the device to reboot after the selection is completed.
5. Select Wiegand communication mode, the device will automatically turn on the repeat Tag filtering enable without any filtering conditions, the filtering interval is 1000ms, users can modify the Tag filtering function according to their own needs.
6. Log in to the webpage, select the event setting interface, open the periodic time trigger event in the inventory trigger event, configure the inventory time and interval according to your needs, and click save after configuration.

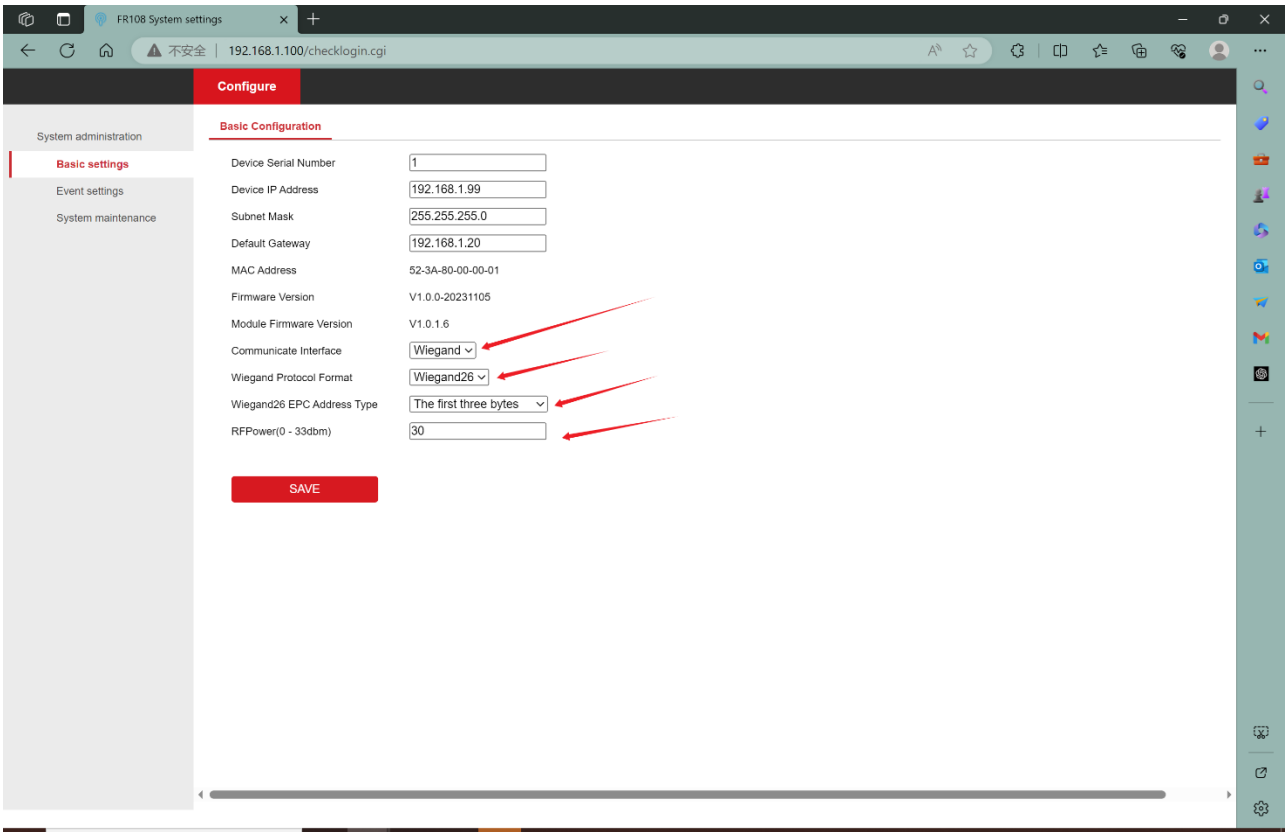


Figure 3-7 Wiegand 26 mode

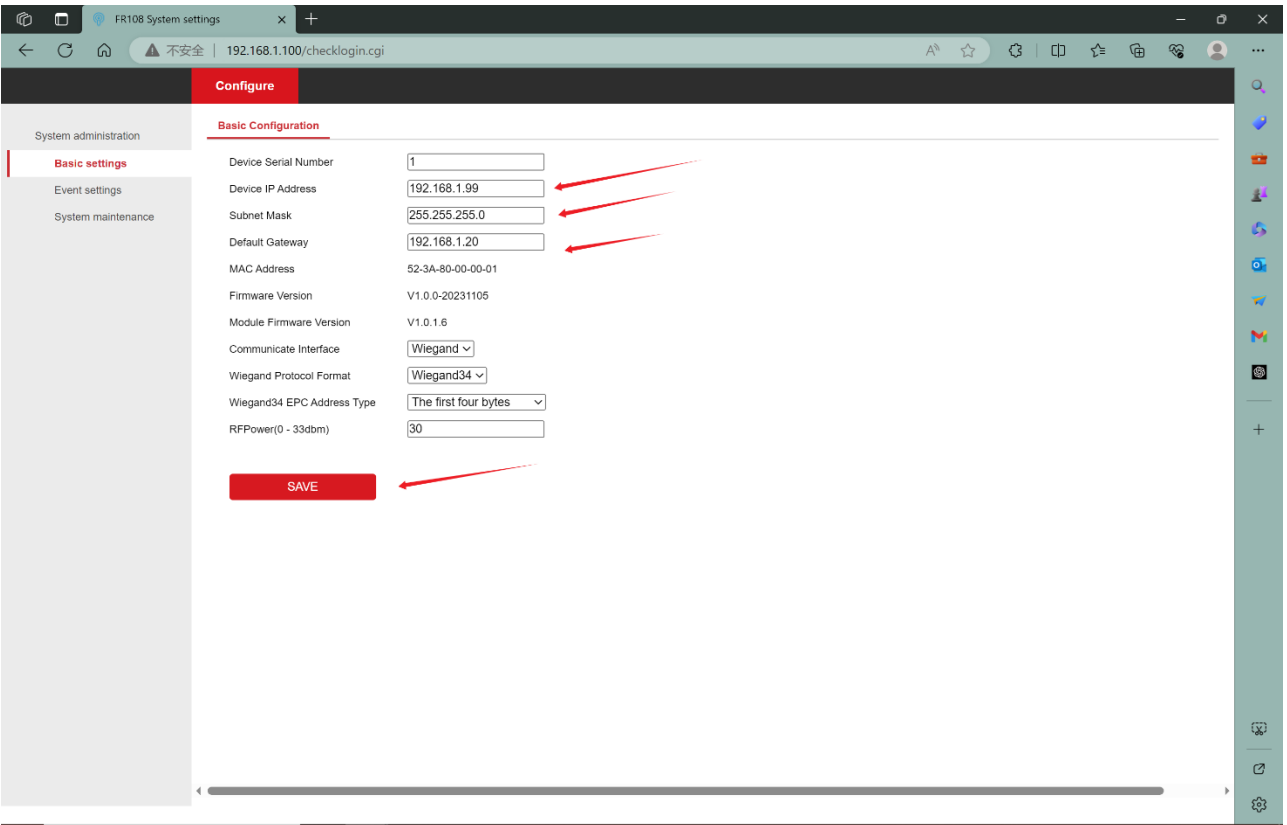
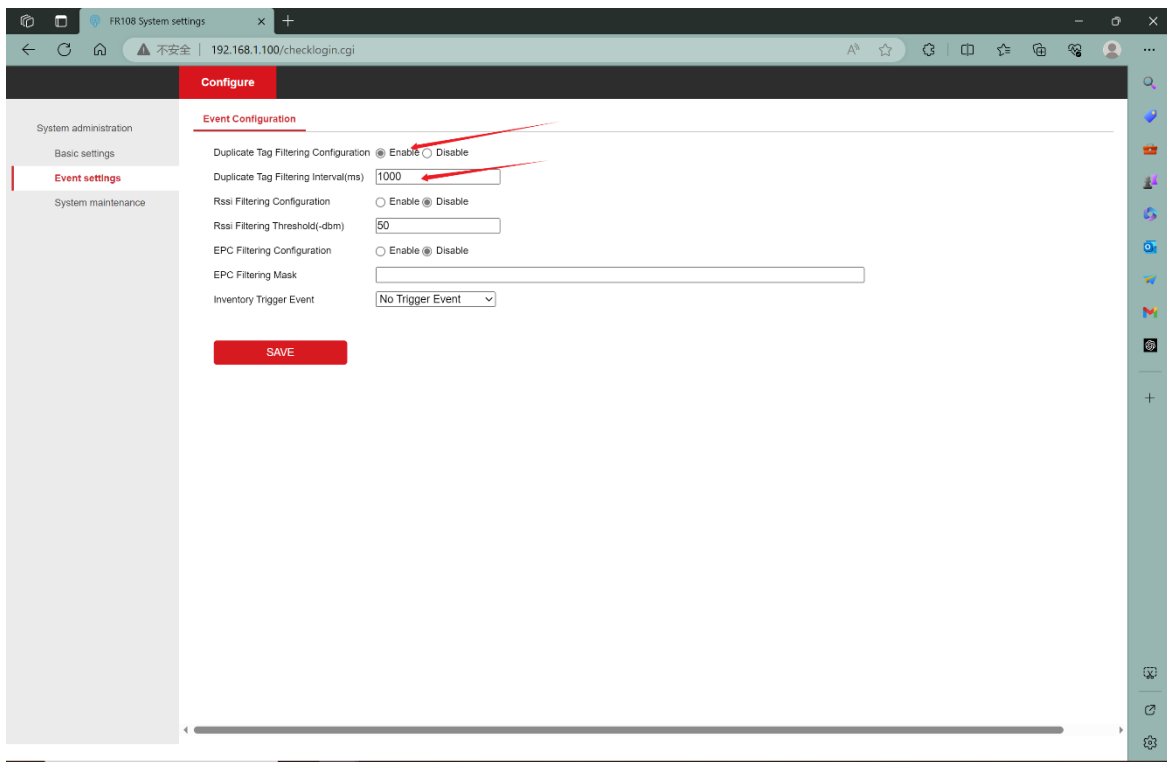


Figure 3-8 Wiegand 34 mode

The Wiegand 34 protocol format is reported as 4 bytes in length and the Wiegand 26 protocol format is reported as 3 bytes in length.

Note

Wiegand mode EPC length needs to meet the Wiegand protocol data length. Wiegand 26 mode EPC length needs to meet at least three bytes, if you choose to customize the address offset, then the Tag EPC length needs to meet at least (address offset starting position (unit byte) + three bytes of length) and above. For example: custom address offset starting position is 4, then the EPC length to meet at least $(4 + 3 = 7)$ bytes. Wiegand 34 protocol is similar.

**Figure 3-9 The device automatically enables repeat label filtering**

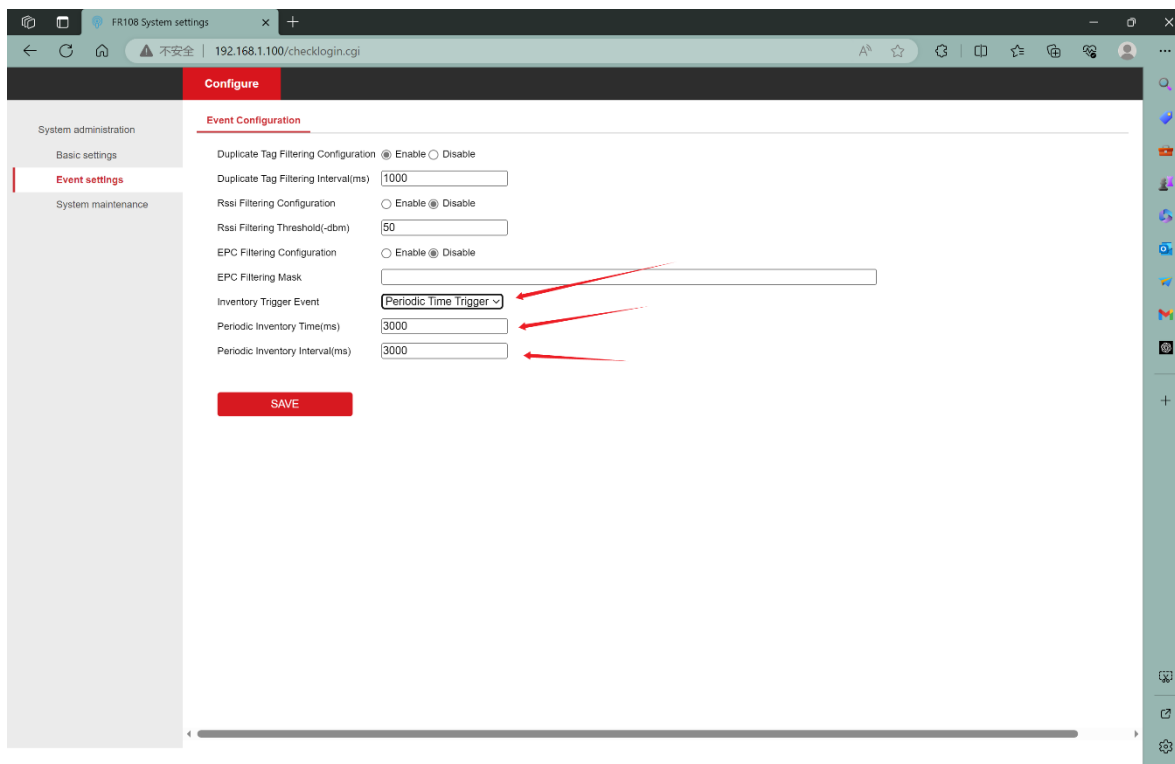


Figure 3-10 Configure device inventory trigger events

3.2.3 Event configuration

The event setting interface includes device label filtering, device inventory triggered events, click save after the configuration is complete, the configuration will take effect immediately the device will not reboot.

Tag Filtering Methods

Inventoried Tag can be filtered according to different filtering methods, by three filtering methods can be configured:

Repeat Tag filtering: the same Tag is reported only once within the filtering time range.

Mask filtering: select the Tags with matching masks at the beginning of the EPC and filter out the unmatched Tags.

RSSI value filtering: you can filter the tags according to the signal sensitivity of the read tags, and filter out the tags with poor signal value.

Note

Mask input for example: XXXX1234ABCD XXXX on behalf of the first two bytes of the EPC any content matches, followed by 1234ABCD need to be labeled EPC 3rd to 6th byte content meets the 1234ABCD to match.

Inventory trigger event:

Once the event is established, the reader is powered on automatically inventory tags according to the event. Cyclic event trigger event function for the device after powering up the automatic inventory for a period of time after a period of hibernation and then enter the inventory mode, and so on and so forth. The inventory time is determined by the periodic inventory time, dormancy time is determined by the periodic inventory interval

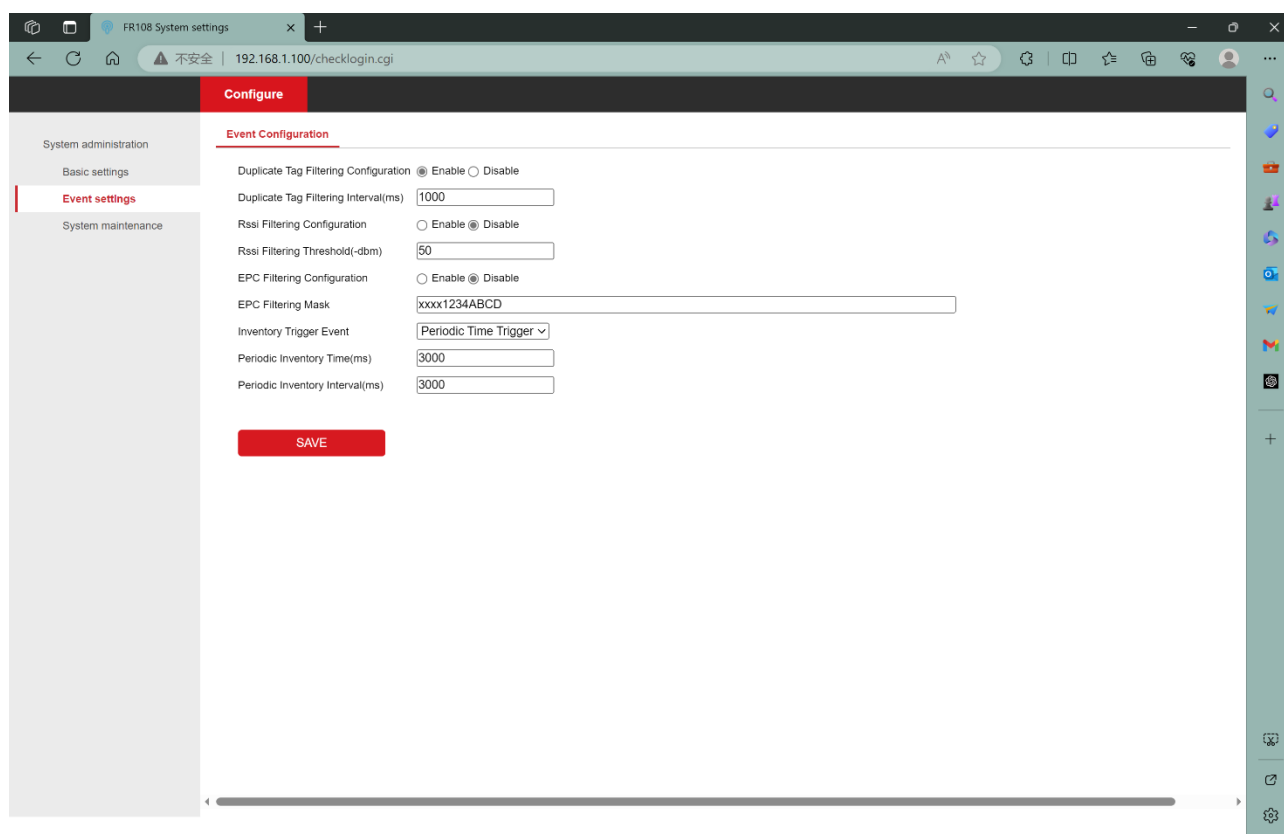


Figure 3-11 Event configuration

3.2.4 System maintenance

System maintenance interface contains firmware upgrade, restart the device, restore the device parameters and other functions, these functions have a greater impact on the device, in order to prevent misuse of the click will be prompted to confirm or not, after confirming that there is no error, click OK.

- Firmware upgrade: Updating the device firmware version.
- Reboot device: device restart.
- Reset Device Parameters: Restore the device parameter information to the default factory state.

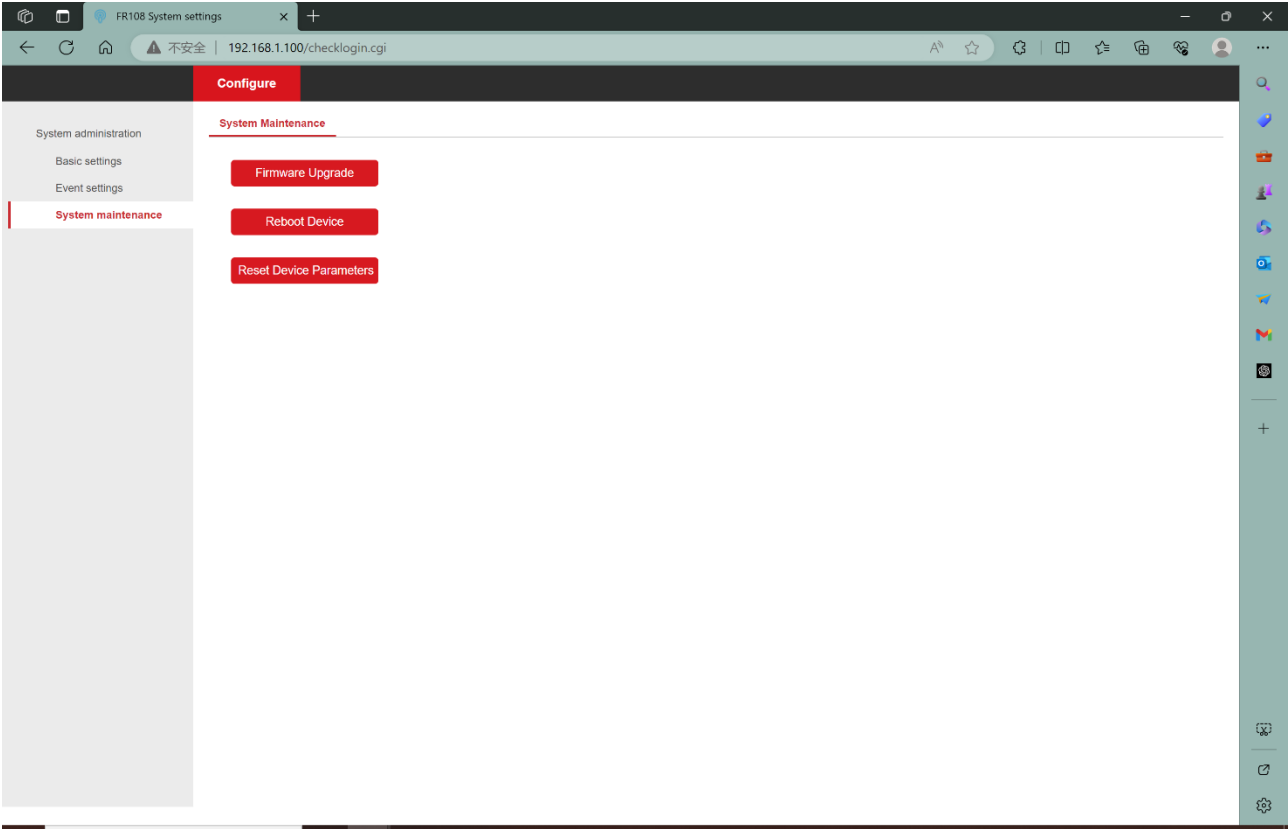


Figure 3-12 System maintenance



See Far, Go Further